

Tissue Flotation Work Station

KD-TH II

Operator's Manual

Please read carefully before using the product and store this manual for future reference

Enterprise standard No. : Q/JKD004-2007

Registration No.: Q330700.C.44.2637-2003

Table of Contents

1. INTRODUCTION	2
2. SAFETY GUIDELINES	2
3. PRODUCT FEATURES	3
4. SPECIFICATIONS	4
5. OVERVIEW	5
6. CONTROL PANEL	6
7. OPERATING ENVIRONMENTAL CONDITIONS	10
8. UNPACKING AND INSTALLATION	11
9. OPERATION	12
9.1 General Unit Setting (ZONE 1)	
9.1.1 Unit on/off Timer Setting	13
9.1.2 Day/Time Setting	14
9.1.3 Adjusting Screen Brightness	14
9.2 Flotation Setting (ZONE 2)	
9.2.1 Countdown Timer Setting for heater	15
9.2.2 Temperature Setting	15
9.2.3 Dish illumination brightness setting	16
9.3 Drying Setting (ZONE 3)	
9.3.1 Countdown Timer Setting for heater	16
9.3.2 Temperature Setting	17
10. PRECAUTIONS	18
11. CLEANING AND MAINTENANCE	19
12. TROUBLESHOOTING	19
13. TRANSPORTATION AND STORAGE	20
14. POST-SALE CUSTOMER SERVICE	20
15. PACKING LIST	22

1. INTRODUCTION

The KD-TH II Tissue Flotation Work Station offers pathology labs the most full-featured tissue flotation/drying instrument available. This instrument has been developed using the proven critical components of earlier models while a series of new innovative enhancements, including adjustable LED dish lighting, were added compared to the common models on market. Due to its reliable performance, compact size, highly intelligent design and easy operation, this device is ideal for pathological research, hospitals, medical schools, and research institutes, as well as food & drug inspection sectors.

2. SAFETY GUIDELINES

- Please carefully read this User Manual before using the unit.
- This product is designed for floatation and drying of tissue sections, not for other unspecified purposes, and it should only be operated by professionals.
- Although the unit has built-in overheating protection control, for your safety and the safety of those working near you, DO NOT place a dry glass dish in the bath when the heaters are on.
- ⚠ The glass dish might be hot and could cause burns if touched, especially when the temperature setting is high; therefore, make sure you are wearing protective gloves before touching the glass dish.
- Always immerse the temperature probe in the water bath while the unit is in operation, assuring that at least one inch of the probe (about ½ of the height of the glass wall) is underwater.
- ⚠ Please place the unit away from flammable or explosive materials and keep out of reach of children.
- ⚠ Do not add water or reagents into dish when the unit is operating. In addition, please ensure that there is no water spillage into the inside of the unit when replenishing the glass dish.
- ⚠ Place the instrument on a firm, steady surface with an inclination not exceeding 5°.
- Do not use any solid object to touch the display screen.

- Do not operate the unit in a high-frequency vibrating environment (e.g., near a centrifuge).

3. PRODUCT FEATURES

1. A two-in-one unit that can be used for both tissue flotation and drying processes.
2. A large front-panel LED screen, of which the brightness is adjustable, clearly displays setting information and is easy to program. The heating status is indicated by signal lights.
3. A fully automatic control system offers the unit a complete line of features and meets different user needs.
4. A glass dish made of high-temperature-resistant borosilicate glass allows clear observation of specimens.
5. The LED illumination system beneath the high-quality glass dish provides a bright and clear view; the light intensity can be adjusted within a wide range.
6. New-generation heating elements provide fast and even heating. They are long-lasting, reliable and energy-saving. In addition, the triple-protection temperature control system ensures safe operating conditions.
7. Using a single-chip microprocessor technology with PID heating control, the temperatures of the water and the drying plate can be precisely controlled. Digital-readouts of the actual temperature of the bath and drying plate are monitored and displayed individually.
8. The USA-made temperature sensor probe (DALLAS Co.) utilizes a durable hinged rotation and a magnetic position detection system for high reliability and resistance to wear and tear, and it can automatically save the operating program.
9. Through the internal memory, all settings are automatically stored and recovered to ease the use of the unit and enable the use of cell phone activated power device.
10. The timers can be individually set for power on/off of the unit, as well as the automatic power off the flotation station and drying plate.

4. SPECIFICATIONS

Unit dimensions: 310×460×135 mm (W×D×H)

Dish dimensions: 210×170×55 mm (W×D×H)

Drying plate size: 250×130 mm (W×D) capacity: approximately 20 slides

Temperature setting range: Flotation 0 ~70°C (0.5°C increments)

Drying 0 ~100°C (0.5°C increments)

Factory default temperature:

Flotation 55°C (0.5°C increments)

Drying 65°C (0.5°C increments)

Temperature fluctuation: ±1°C

Voltage: AC 100V-120V/210V-240V

Frequency: 50Hz/60Hz

Fuse: F10A L 125 VAC/F6.3A L 250VAC

Power: 450W

Weight: 7 Kg

5. OVERVIEW

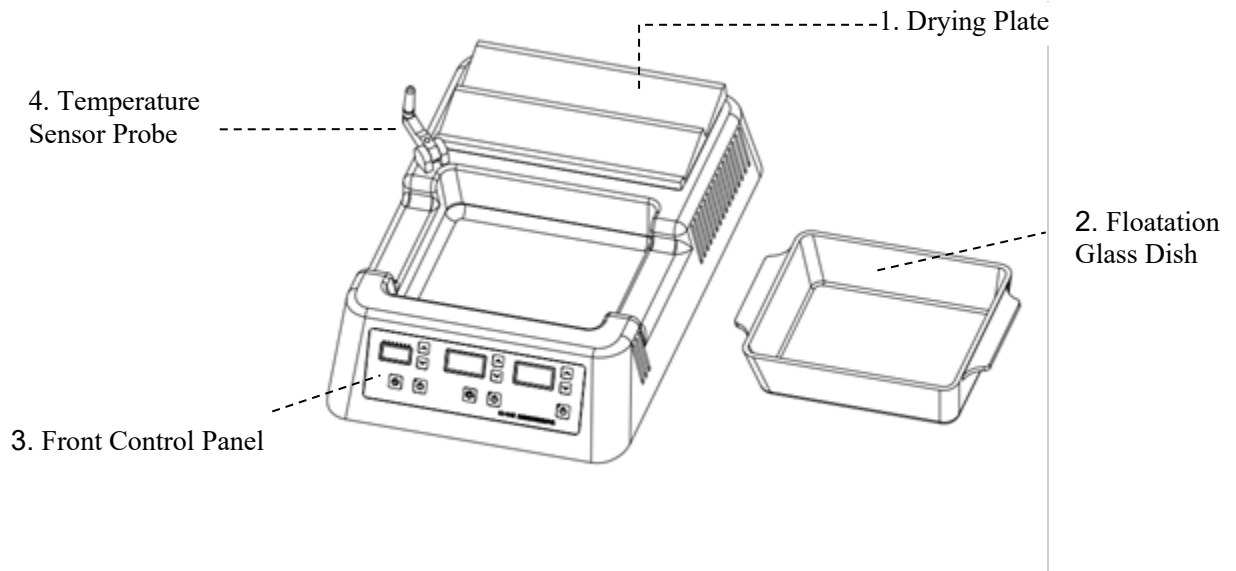

Fig. 1 Front view

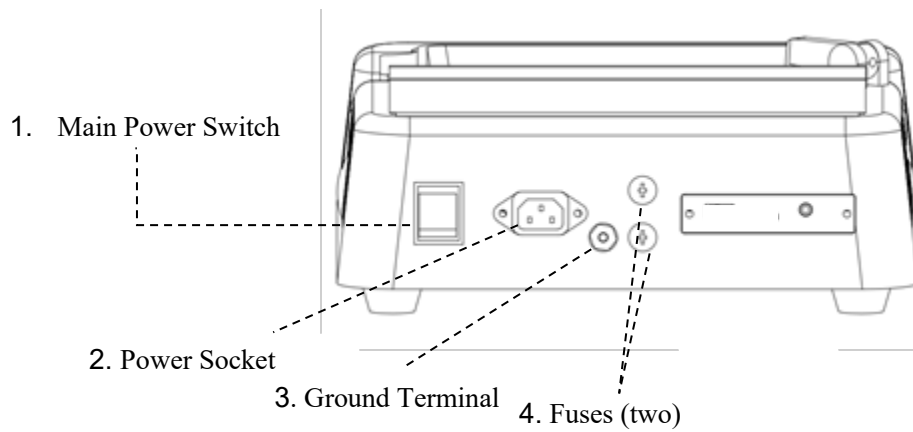
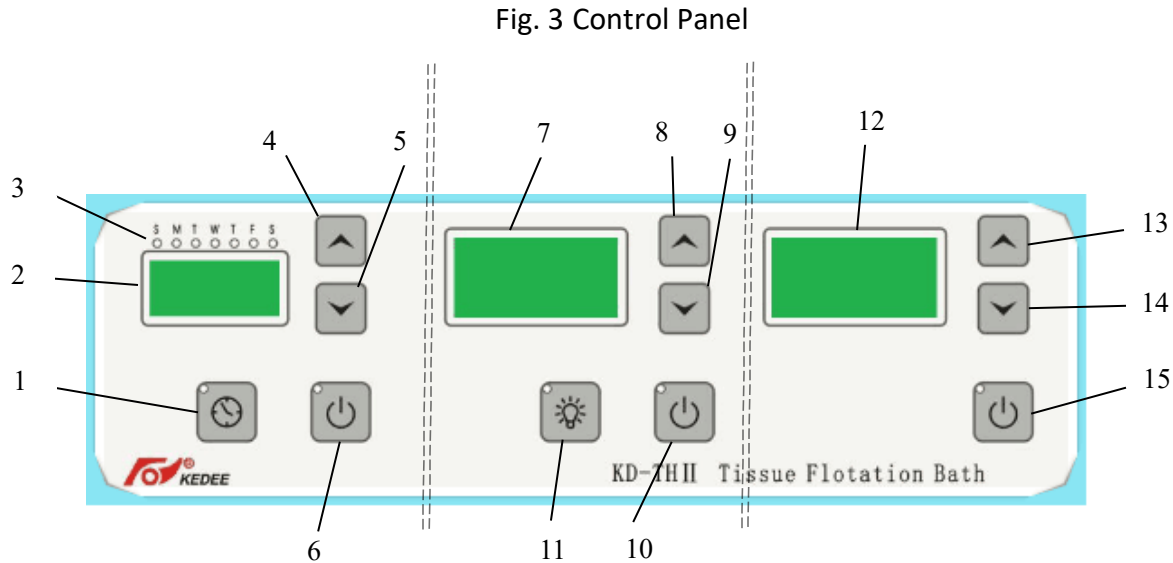

Fig. 2 Rear view

6. CONTROL PANEL

6.1 Control Panel Overview



Zone 1
**Unit time calibration /
 ON/OFF timer setting /
 ON/OFF control**

- 1. Time Setting Key
- 2. Timer Display
- 3. Weekday LED Indicator
- 4. Increase-Key
- 5. Decrease-Key
- 6. ON/OFF Key

Zone 2
**Flotation temperature and
 time /Light control**

- 7. Flotation temperature/ time
Display
- 8. Increase-Key
- 9. Decrease-Key
- 10. Flotation Heater ON/OFF
Key
- 11. Dish Light ON/OFF Key

Zone 3
**Drying Temperature and
 time control**





- 12. Drying temperature/ time
Display
- 13. Increase-Key
- 14. Decrease-Key
- 15. Drying Plate Heater
ON/OFF Key

6.2 ZONES and Keys ('click' or 'press and hold' for different functions)





ZONE 1 is for unit time setting / ON/OFF timer setting.

🕒 Time Setting Key 1:

(A) Set unit ON/OFF timer:

- Click  **Key 1** to view the settings for automatically turning the unit on or off;
- Press and hold this key one time to enter the setting mode for unit on/off;
 - Click **Decrease-Key 5** to choose the weekday (Monday to Sunday from left to right) and click **Increase-Key 4** to choose ON or OFF for timer setting on the selected weekdays;
 - Click  **Key 1** to confirm the weekday selection and set the ON or OFF time (hour) accordingly by using **Increase-Key 4** and **Decrease-Key 5**; similarly, click  **Key 1** to accept the on/off hour setting and set the ON/OFF minute; click  **Key 1** to accept the on/off minute setting.

(B) Clock setting:

- Press and hold  **Key 1** twice to enter the unit clock setting mode (Weekday LED Indicators will flash);
 - Click **Increase-Key 4** or **Decrease-Key 5** to choose the weekday for setting;
 - Click  **Key 1** to accept the weekday selection and then set the hour by clicking **Increase-Key 4** or **Decrease-Key 5**; similarly, click  **Key 1** to accept the hour setting and set the minute; click  **Key 1** to save the setting.

Time Display 2 is to display current time or on/off timer setting

Weekday LED Indicator 3: Monday to Sunday from left to right

Increase-Key 4 :

- Click it to increase the number when the unit is in the timer setting mode or time setting mode;
- When the signal light of  **Key 6** goes off, press and hold **Increase-Key 4** to increase the display brightness.

Decrease-Key 5 :

- Click it to decrease the number when the unit is in the timer setting mode or time setting mode;
- When the signal light of  **Key 6** goes off, press and hold **Decrease-Key 5** to decrease the display brightness;

 Control Key 6 :



- Press and hold this key to turn off the heaters for floatation and drying;
- When the time setting mode is activated, click this key to exit the time setting mode.

ZONE 2 is to set up the temperature and heating duration of floatation heater, as well as adjust the illumination brightness.



Floatation Temperature Display 7:

- Displays the water temperature in the glass dish;
- Displays the illumination brightness value when press and hold Illumination Control  **Key 11**;
- Displays the setting status (ON/OFF) and the countdown operation time of floatation heater when the unit is in floatation time setting mode (press and hold Key 10 for time setting).

Increase-Key 8:

- Click this key to increase the temperature setting of floatation heater when the unit is in floatation temperature setting mode;
- Press and hold this key to view the water temperature setting for floatation;
- Click this key to increase the illumination brightness of glass dish when **Display 7** shows the brightness value by pressing and holding Illumination Control  **Key 11**;
- Click this key to turn on the counting down of operation time when **Display 7** shows OFF (indicating the counting down of operation time stops) after pressing and holding  **ON/OFF -Key 10**; if Click **ON/OFF -Key 10** again, **Display 7** will show the countdown operation time (1-12 hours) and click **Increase-Key 8** can increase the operation time

Decrease-Key 9:

- Click this key to decrease the temperature setting of floatation heater when the unit is in floatation temperature setting mode;
- Press and hold this key to view the actual water temperature in the glass dish;
- Click this key to decrease the illumination brightness of glass dish when **Display 7** shows the brightness value by pressing and holding Illumination Control  **Key 11**;
- Click this key to turn off the counting down of operation time when **Display 7** shows ON (indicating the counting down of operation time begins) after pressing and holding  **ON/OFF -Key 10**; if Click **ON/OFF -Key 10** again, **Display 7** will show the countdown operation time (1-12 hours) and click **Decrease-Key 9** can decrease the operation time;

 **ON/OFF -Key 10**

- Click this key to turn on/off the floatation heater; the indicator stays on when the heater is operating and flashes when the unit is in a setting mode or the temperature sensor probe isn't placed into the glass dish;
- Press and hold this key to enter the countdown timer setting mode for heater operation
 - Click **Increase-Key 8** to enter the setting mode for the countdown timer (ON), which can be turned off by clicking **Decrease-Key 9**;
 - Click **ON/OFF -Key 10** again to set up the heater operation countdown time in a range of 1 to 12 hours by clicking **Increase-Key 8** and **Decrease-Key 9** ; click  **ON/OFF -Key 10** to accept the setting;
 - The unit beeps, automatically stops heating, and enters a standby mode when the operation time is finished.

Illumination Control Key 11

- Click this key to turn on/off the illumination light;
- Press and hold this key until the indicator light flashes to view the illumination brightness value in **Display 7**;
 - Click **Increase-Key 8** or **Decrease-Key 9** to set the illumination brightness value in a range of 0 -240;
 - Click Illumination Control  **Key 11** again to set the setting and exit the setting mode.

ZONE 3 is to set up the temperature and heating duration of the drying plate.

Drying Temperature Display 12:

- Displays the temperature of the drying plate;
- Displays the setting status of ON/OFF and the countdown operation time of the drying plate when the unit is in time setting mode (press and hold Key 15 for time setting).

Increase-Key 13:

- Click this key to increase the temperature setting when the unit is in temperature setting mode of the drying plate;
- Press and hold this key to view the temperature setting of the drying plate;
- Click this key to turn on the counting down of operation time when **Display 12** shows OFF (indicating the counting down stops) after pressing and holding  **On/Off-Key 15** for drying; if Click **On/Off-Key 15** again, **Display 12** will show the countdown operation time

(1-12 hours) and click **Increase-Key 13** can increase the operation time of the drying plate.

Decrease-Key 14:

- Click this key to decrease the temperature setting when the unit is in temperature setting mode of the drying plate;
- Press and hold this key to view the actual temperature of the drying plate;
- Click this key to turn off the counting down of operation time when **Display 12** shows ON (indicating the counting down of operation time begins) after pressing and holding  **ON/OFF -Key 15**; if click **On/Off-Key 15** again, **Display 12** will show the countdown operation time (1-12 hours) and click **Decrease-Key 14** can decrease the operation time

ON/OFF -Key 15

- Click this key to turn on/off the heating of the drying plate; the indicator stays on when the heater is operating and flashes when the unit is in a setting mode;
- Press and hold this key to enter the countdown timer setting mode for heater operation
 - Click **Increase-Key 13** to enter the setting mode for the countdown timer (ON), which can be turned off by clicking **Decrease-Key 14**;
 - Click  **ON/OFF -Key 15** again to set up the heater operation countdown time in a range of 1 to 12 hours by clicking **Increase-Key 3** and **Decrease-Key 14**; click **ON/OFF -Key 15** to accept the setting;
 - The unit beeps, automatically stops heating, and enters a standby mode when the operation time is finished.

7. OPERATING ENVIRONMENTAL CONDITIONS

Ambient temperature 5 °C to 40 °C,

Relative humidity ≤ 80%

Low dust; Corrosive gas free; Well-ventilated

Atmospheric pressure 860 hpa ~ 1060 pha

8. UNPACKING AND INSTALLATION

1. Please inspect the shipping container carefully for any signs of damage to the outer carton. In the event of apparent mishandling, note the damage accordingly on the bill of lading and take pictures for future reference. Save the shipping carton and all packing materials for proof of noted damage and / or for future shipment of the instrument back to the manufacturer for any future service needs. Failure to document external damage to the carton may limit your ability to obtain compensation for damage.
2. Remove the equipment along with the protective cover from the shipping carton carefully. Notify the carrier immediately if there is any visible damage to the contents or any missing of the items listed in the packing list.
3. Remove the protective cover and place the unit on a stable workbench with an inclination not exceeding 5°.
4. Please do not operate the unit in an area close to flammable and explosive materials or magnetic interference sources.
5. Gently seat the dish into the flotation bath section.
 - ⚠ Be certain that the power switch is on 'OFF' position and then plug the unit to a properly grounded 120V AC outlet. Turn on the switch and the green light indicates power on;
 - ⚠ Please use only the power cord provided by the manufacturer and connects the power cord to the unit before plugging into the power supply outlet.

9. OPERATION

- Fill the glass dish with water to the desired level. It is recommended to fill the glass dish to approximately 4/5 of the total depth or 3/8" (.5 cm) from the top of the dish. To ensure sensor accuracy, a minimum of 1" of water should cover the probe.

NOTE: Never leave a dry dish in the heated bath area with the heater on. If the water level is below the sensor, the controller will stop heating the water bath and indicate an error by flashing the LED indicator on the top left corner of Key (11) and beeping after 3 minutes of light flashing.

- The heating temperature has been set at 55°C for floatation and 65°C for drying by the manufactory. If these settings meet your needs, the unit is ready for immediate use without resetting temperatures.

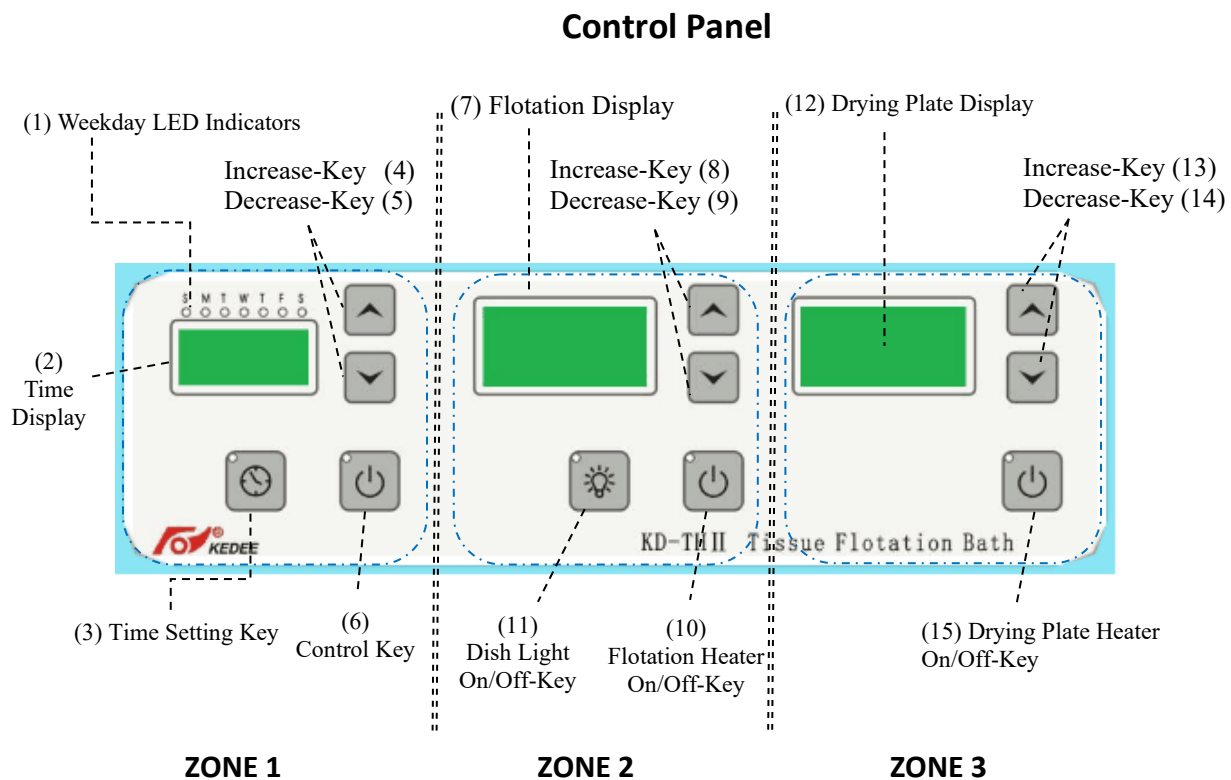



Figure 4

- Mark instruction:  ground wire; Switch O is off power; Switch I is on power;

 indicates that the surface is hot.

9.1 FUNCTIONS OF ZONE 1

- This ZONE has four functions: day and time setting, unit on/off timer setting, and LED display brightness adjustment.

9.1.1 Unit on/off timer setting

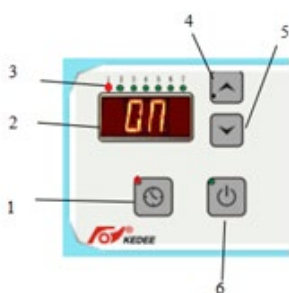

Fig. 5-1

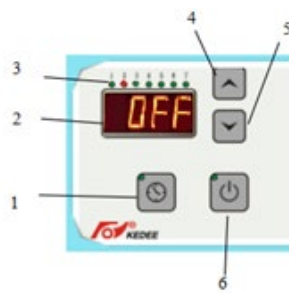

Fig. 5-2

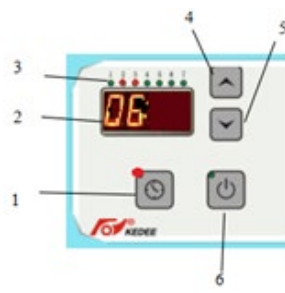

Fig. 5-3

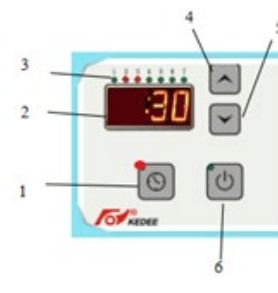

Fig. 5-4

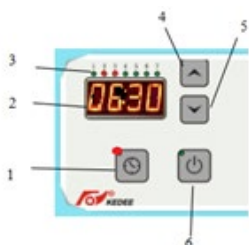

Fig. 5-5

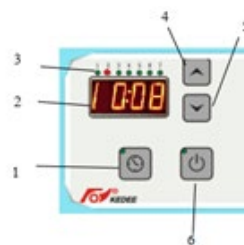

Fig. 5-6

- After selecting the weekdays and On/Off status for timer setting (Fig. 5-1 and 5-2), click ⌚ Key (1) to set up the hour (0-23) by using Keys (4) and (5) (Fig. 5-3); click Key (1) to save the hour setting and set the minute (00-59) by using Keys (4) and (5) (Fig. 5-4).

Note: The timer for unit on or off can only be set the same for all selected weekdays.

- After finishing the unit On/Off timer setting, click ⌚ Key (1) to successfully save the settings, which will be indicated by two short beeping sounds, and Display (2) shows the timer settings (Fig. 5-5);
- The signal light of Key (1) goes off and Display (2) automatically changes to display the current time (Fig. 5-6) after 10 seconds or by clicking ⌚ Key (1) again.

Click 🏠 Key (6) to stop timer setting at any time.

Click ⌚ Key (1) (the signal light of the key turns on) to view the preset On/Off time (Fig. 5-5)

9.1.2 Day and time setting

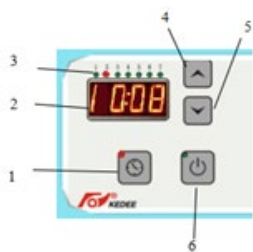

Fig. 6-1

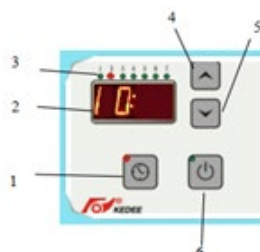

Fig. 6-2

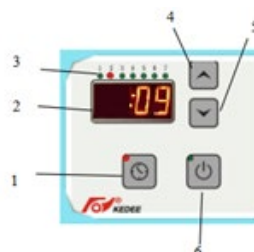

Fig. 6-3

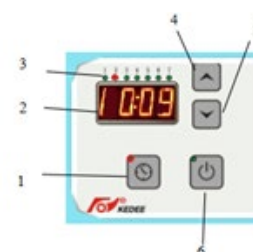

Fig. 6-4

- Press and long-hold 🕒 Key (1) twice until the weekday indicator lights flash, then click Key (4) or (5) to select the correct weekday (Monday to Sunday from left to right) (Fig. 6-1);
- Click 🕒 Key (1) to accept the weekday selection and then select the hour by using Key (4) or (5) (Fig. 6-2);
- Click 🕒 Key (1) to accept the hour selection and then select the minute by using Key (4) or (5) (Fig. 6-3);
- Click 🕒 Key (1) to save the settings (Fig. 6-4)

Click 📶 Key (6) to stop clock setting at any time.

9.1.3 Adjusting screen brightness

- When the unit is on and the LED indicator of 📶 Key (6) is off (Figure 8-1), press and hold Key (4) or (5) to adjust the brightness of all three display screens (Figure 8-1 and 8-2).



Figure 8-1

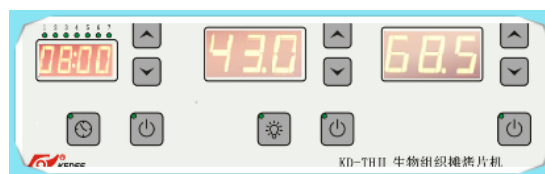





Figure 8-2

9.2 FUNCTIONS OF ZONE 2

- This ZONE has three functions: floatation heater countdown timer setting, floatation temperature setting, and illumination brightness adjustment

9.2.1 Countdown timer setting for floatation heater

- Under the normal operating status, press and hold the  Key (10) to enter the heater countdown timer setting mode (Display 7 shows either 'ON' or 'OFF'); click Key (8) or (9) to turn on or off the countdown timer (Fig. 9-1 and 9-2), respectively;
- Click  Key (10) to set up heating duration between 1 ~ 12 h by using Key (8) or (9) (Fig. 9-3).

The setting will be automatically saved, and the unit returns the normal operating status after 10 seconds or by clicking  Key (10).

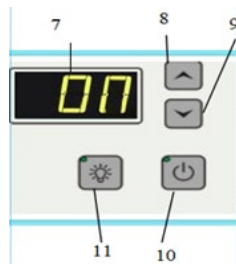

Fig. 9-1

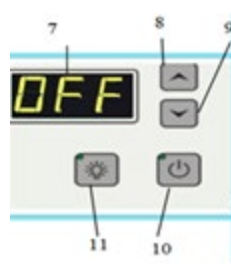

Fig. 9-2

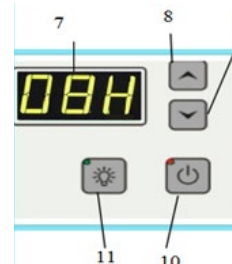



Fig. 9-3

The heater will be automatically turned off with a beeping alert and enter the standby mode once the preset countdown time is up.

9.2.2 Floatation temperature setting

- Under the normal operating status, click Key (8) and (9) until the number on Display (7) flashes; click Key (8) and (9) again to adjust the temperature setting of the floatation heater in the range of 0-70 °C;
- The setting will be automatically saved and the unit returns the normal operating status after 10 seconds or by clicking  Key (10) (Figure 10).

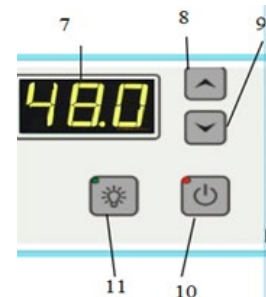

Figure 10

Note:

When click  Key (10), both of the LED light on the left top corner of the key and Display 7 turn on, indicating that the floatation heater is running; the off-status of the LED light indicates the heater stops running; and the flashing of the LED light might be caused by the error that the temperature sensor probe is not placed in the floatation dish.



Figure 11

9.2.3 Illumination setting of the floatation dish

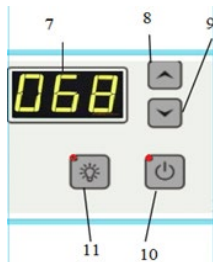





Figure 12

- Click  Key (11) to turn on or off the illumination light on the bottom of the glass dish;
- When the LED light at the top left corner of the key and the illumination light are on, press and hold  Key (11) until the LED light flashes to view the brightness value on the Display (7) (Figure 12);
- Click Key (8) or (9) to adjust the brightness value in the range of 0-124.
- The brightness setting will be automatically saved and the unit returns the normal operating status after 10 seconds or by clicking  Key (11)



9.3 FUNCTIONS OF ZONE 3

- This ZONE has two functions: countdown timer setting for drying plate heater and drying temperature setting

9.3.1 Countdown timer setting for drying plate heater

- Under the normal operating status, press and hold the  Key (15) to enter the

heater countdown timer setting mode (Display 12 shows either 'ON' or 'OFF'); click Key (13) or (14) to turn on or off the countdown timer, respectively;

- Click  Key (15) to set up heating duration between 1 - 12 h by using Key (13) or (14) (Figure 13-1).
- The setting will be automatically saved and the unit returns the normal operating status after 10 seconds or by clicking  Key (15).

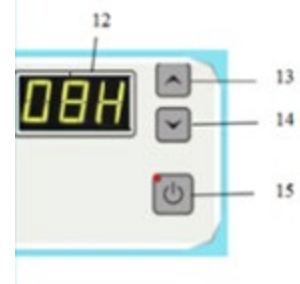



Figure 13

The heater will be automatically turned off with a beeping alert and enter the standby mode once the preset countdown time is up.

9.3.2 Drying temperature setting

- The setting will be automatically saved and the unit returns the normal operating status after 10 seconds or by clicking  Key (15) (Figure 14).

- Under the normal operating status, press and hold Key (13) to view the temperature setting for drying; press and hold Key (14) to view the actual temperature of the unit; and click  Key (15) to turn off the heater for drying;

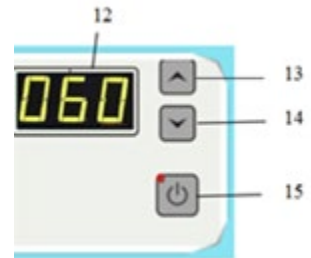



Figure 14

- After the drying plate heater is turned off, the Display (12) shows a warning sign of "HOT" if the plate temperature is $\geq 50^{\circ}\text{C}$ and goes off if the plate temperature is $< 50^{\circ}\text{C}$

Note: This unit can automatically store all temperature settings into memory chips, and therefore, it can directly start running without temperature presetting prior to each use as long as the temperature sensor probe is placed into the glass dish; if the probe is not in the dish, the floatation heater enters a standby mode, the signal light of  Key (10) in the ZONE 2 remains flashing, and the unit will beep after 3 minutes.

10. PRECAUTIONS

1. Please check the exterior when the unit arrives and read the user manual prior to use.
2. Please use the grounded three-way power supply.
 - ⚠ Use a dedicated outlet for supplying power to the unit to avoid interference and overloading of the circuit.**
 - ⚠ Only the power line provided with the instrument should be used, and the power supply should be well grounded.**
 - ⚠ Please use a separate power outlet to avoid any possible interference.**
3. Please do not place the unit near flammable or explosive materials.
4. The unit has built-in overheating protection control, which will automatically shut down the heater once the temperature exceeds a dangerous level of 100°C (abnormal status), and the heater will return to work when the temperature enters the normal range.
 - ⚠ The glass dish might become very hot and could cause burns if touched. For your safety, never directly touch any heating elements of the unit.**
 - ⚠ Never place a dry glass dish in the bath when the heaters are on. Always immerse the temperature probe in the water bath while the unit is in operation, assuring that at least one inch of the probe is underwater.**
5. Please do not add too much water in the dish causing the water spill over into the unit.
6. Please turn off the power supply before changing the fuse and the fuse must be the same size and spec as the original one.
7. It is unnecessary to unplug the flotation bath when it is not being utilized. It is recommended that the heaters be turned off when the bath is not in use for extended periods of time to minimize evaporation of water from the water dish.
8. Please do not touch the screen with sharp and hard objects.

11. CLEANING AND MAINTENANCE

1. Make sure the power is cut off before cleaning the unit;
2. Clean the unit surface with soft cloth and mild detergent to avoid damage, and do not use organic cleanser such as acetone or benzene on the unit surface;
3. Please keep the glass dish clean by regularly washing it with warm water so that the illumination light can pass through the dish wall and provide a good visibility;
4. Do not spill any liquid into the side of the unit;
5. Disconnect the unit with the power supply, protect it from dust by using a cover, and place it in a well-vented dry environment free of corrosive gas if the unit is not in use for extended periods of time.

12. TROUBLESHOOTING

Faults	Possible reasons	Suggestions
No response when turning the unit on	Power supply is not connected	Check the power supply connection and restart the unit
	The switch is not on 'ON' position properly	Switch the power OFF and back to ON again, and the indicator should be on
	The fuse is not connected	Check the fuse and replace the defective fuse
No heating	The fuse is defective	Replace the fuse
	The heating ZONE is defective	** Replace the heater
	The temperature sensor is defective	** Replace the temperature sensor
	The relay of the main control panel is defective	**Replace the relay of the main control panel
	Some connection sites are not connected well	** Open the bottom cover to identify the loose connection site
No illumination	Some connection sites are not connected well	** Open the bottom cover to identify the loose connection site
	LED is defective	** Change the LED

** Call for technical support and the device should only be repaired by technicians authorized by our company.

13. TRANSPORTATION AND STORAGE

- During transportation, the product should be handled with care, kept dry and the top up.
- Please keep your unit in a dry (relative humidity \leq 80%) and clean environment free of corrosive gas if you stop using it for a period of time.

14. POST-SALE CUSTOMER SERVICE

○ 30-Day Satisfaction Guaranteed Return Policy

If you are unsatisfied with your purchase for any reason, you have **30** days from the date of purchase to request a full refund. You may return the device and device accessories (collectively, the "Product") in accordance with the terms below.

To qualify for a refund, all the following conditions must be met:

A return authorization must be requested from our customer service team within 30 days of your purchase date. To request a return authorization, please contact our customer service.

You must return the Product to receive a refund. Returned Product(s) must be in good physical condition (not physically broken or damaged). All accessories originally included with your purchase must be included with your return.

Additional terms and conditions:

Shipping and handling charges and taxes paid (such as state, customs, or VAT) are not refundable.

You are responsible for and must prepay all shipping charges and you assume the risk of loss or damage to the returned Product(s) while in transit back to the manufactory.

If you return the Product without a return authorization or without all parts and

accessories originally included with your purchase, the manufactory retains the right to either refuse acceptance of such return or charge you a restocking fee of 15% of the original price of the Product(s) or the retail value of the missing parts and accessories, whichever is higher.

- **Product Warranty**

The manufactory warrants to the original purchaser that your device and device accessories (collectively, the "Product") shall be free from defects in materials and workmanship under normal use for a period of one (1) year from the date of purchase (the "Warranty Period").

During the warranty period, the product will be repaired or replaced at no shipping and handling charges. After the warrant period, the manufactory provides maintenance service at a low cost.

The manufactory shall not be liable for any incidental, indirect, consequential, irresistible force (e.g., lightning or earthquake) - or misoperation-caused damages (e.g., the product has been used for the purposes other than floatation and drying of tissue slides) of the product.

Please feel free to contact us if you have any suggestions regarding our products and customer service!

Exclusively distributed by Springside Scientific LLC (Durham, NC) in North America

Tel: 919 864 8821

E-mail: contactus@springsidesci.com

www.springsidesci.com

Packing List

Thank you very much for choosing our products! Please read Operator's Manual carefully prior to use and follow the instructions for operation.

NO.	Item	QTY	Note
1	KD-TH II Flotation Work Station	1	
2	Power cord	1	
3	Fuse (F6.3A)	2	
4	Glass dish	1	
5	Service toolbox	1	
6	Product Warranty Card	1	
7	Operator's manual	1	
	Packing list	1	